

Moving
Rehabilitation
Forward™

ADAPTA®











User Manual

ADP400 Traction Table



TABLE OF CONTENTS

Adapta® ADP400

 FOREWORD	1	 MAINTENANCE	18
▶ Product Description	1	▶ Cleaning	18
 ABOUT ADAPTA ADP400 TABLE	2-4	▶ Service	18
▶ Precautionary Instructions	2	▶ Warranty Repair/Out of Warranty Repair	18
▶ Cautions	3	 WARRANTY	19
▶ Warnings	3-4		
▶ Dangers	4		
 NOMENCLATURE	5		
▶ Table Familiarization	5		
 TECHNICAL SPECIFICATIONS	6-11		
▶ Specifications	6		
▶ Table Dimensions	7		
▶ Cushion Dimensions	8		
▶ Electromagnetic Compatibility Tables	9-11		
 SETUP	12-14		
▶ Contents of Crate	12		
▶ Glide Leveler Adjustments	12		
▶ Attaching Traction Unit Stand to Table	13		
▶ Mounting Traction Unit to Stand	14		
 OPERATION	15-17		
▶ Adjusting Table Sections	15-16		
▶ Table Height Adjustment	16		
▶ Relocating the Table (with Optional Retractable Caster)	17		

This manual has been written for the owners and operators of the Adapta ADP400 traction table. It contains general instructions for operation, precautionary instructions, and maintenance recommendations. In order to obtain maximum life and efficiency from your Adapta ADP400 traction table, and to assist in the proper operation of the unit, read and understand this manual thoroughly.

The specifications put forth in this manual were in effect at the time of the publication. However, owing to DJO, LLC's policy of continuous improvement, changes to these specifications may be made at any time without obligation on the part of DJO, LLC.

Before administering any treatment to a patient, you should become acquainted with the operating procedures, as well as the warnings, and precautions.

Product Description

The Adapta ADP400 offers state-of-the-art traction technology. With its outstanding design features, stability and ease-of-operation, the Adapta ADP400 traction table is the perfect complement to Triton, TX or Tru-Trac traction units. The adjustable head and lumbar sections also adapt to all common treatment positions allowing the ADP400 to double as a treatment table. The Adapta ADP400 features the following: an electric hand control high-low adjustment, a full working surface, and a lumbar section that separates to eliminate friction during lumbar traction.

This equipment is to be used only under the prescription and supervision of a licensed practitioner.

ABOUT ADAPTA ADP400 TABLE

PRECAUTIONARY INSTRUCTIONS

The precautionary instructions found in this section and throughout this manual are indicated by specific symbols. Understand these symbols and their definitions before operating this equipment. The definitions of these symbols are as follows:



Caution -

Text with a "CAUTION" indicator will explain possible safety infractions that could have the potential to cause minor to moderate injury or damage to equipment.



Warning -

Text with a "WARNING" indicator will explain possible safety infractions that will potentially cause serious injury and equipment damage.



Danger -

Text with a "DANGER" indicator will explain possible safety infractions that are imminently hazardous situations that would result in death or serious injury.

NOTE:

Throughout this manual "NOTE" may be found. These Notes are helpful information to aid in the particular area or function being described.

CAUTION

- Read, understand, and practice the precautionary and operating instructions found in this manual. Know the limitations and hazards associated with your treatment table. Observe any and all precautionary and operational decals placed on the unit.
- DO NOT operate this table in an environment where other devices are being used that intentionally radiate electromagnetic energy in an unshielded manner. Portable and mobile RF communications equipment can affect Medical Electrical Equipment.
- This table generates, uses, and can radiate radio frequency energy and, if not installed and used in accordance with the instructions, may cause harmful interference to other devices in the vicinity. However, there is no guarantee that interference will not occur in a particular installation. Harmful interference to other devices can be determined by turning this table on and off. Try to correct the interference using one or more of the following: reorient or relocate the receiving device, increase the separation between the equipment, connect the table to an outlet on a different circuit from that which the other device(s) are connected and consult the DJO, LLC Service Department for help.
- Keep table out of high moisture environments.
- This table should be operated, transported, and stored in temperatures between 0° F (-18° C) and 140° F (60° C), with relative humidity ranging from 30% - 80%.
- Do not exceed table weight capacity of 400 lbs (182 kg).

CAUTION

- Support the table section(s) with both hands when making any adjustments.
- Inspect cables and connectors before each use.

WARNING

- U.S. federal law restricts this device to sale by, or on the order of, a licensed practitioner.
- Make certain that the table is electrically grounded by connecting only to a grounded electrical service receptacle conforming to the applicable national and local electrical codes.
- Care must be taken when operating this equipment adjacent to or stacked with other equipment. Potential electromagnetic or other interference could occur to this or other equipment. Try to minimize this interference by not using other equipment in conjunction with it.
- Do not leave the table unlocked and unattended at any time.
- Never place your hands and feet near the working mechanism of the table when making any and all adjustments to height or table sections.
- Do not sit or allow patients to sit on the Head Section of the table. The Head Section will involuntarily lower as it is not designed to support sitting.

ABOUT ADAPTA ADP400 TABLE

Adapta® ADP400



WARNING

- Use only accessories that are specially designed for the Adapta ADP400 traction table. Do not use accessories manufactured by other companies on the Adapta ADP400. DJO, LLC is not responsible for any consequence resulting from using products manufactured by other companies. The use of other accessories or cables may result in increased emissions or decreased immunity of the Adapta ADP400.
- When making adjustments to the table sections, make certain the patient weight is removed before adjusting.
- Do not lift table by Head Section.
- Never transport a patient on the ADP400 table. This table is not designed to support a patient during transport.
- Do not smoke on or around the table.
- Do not allow any unsupervised patient access to the traction table.
- The table sections should be locked before the loading or unloading of a patient. Do not reposition or allow the patient to get on or off the table while the table is ascending or descending.
- This table should only be operated under the prescription and supervision of a licensed medical practitioner that is familiar with the precautionary measures and operational functions associated with the table being used.



DANGER

- Do not allow anything to be under the table while the table is in operation.

NOMENCLATURE

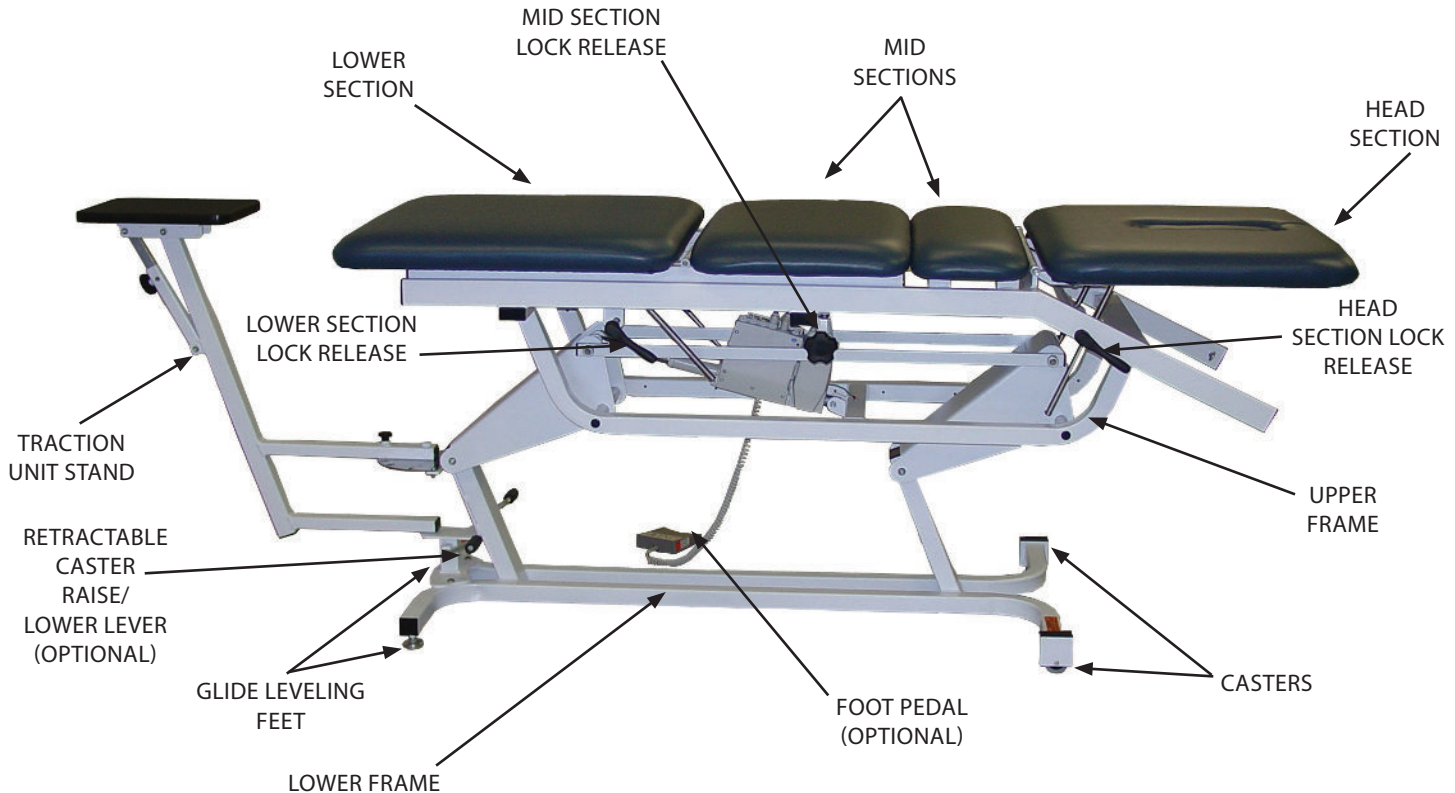

Adapta® ADP400

TABLE FAMILIARIZATION



TECHNICAL SPECIFICATIONS

Adapta® ADP400

Operation	120V	230V
Rated Frequency:	60 Hz	50/60 Hz
Current:	1.6A	1.0A
Power Input:	200W	230W
Fuses:	1.6A (Non-serviceable)	1.0A (Non-serviceable)
Lifting Capacity:	400 lbs (182 kg)	400 lbs (182 kg)
Protected:	Class I, Type B 	Class I, Type B 
Duty Cycle:	10%	10%
Table Length (Head to Toe):	77 in (195.6 cm)	77 in (195.6 cm)

Meets Directive 93 /42 /EEC
IEC/UL/EN: 60601-1
EN 60601-1-2
CAN/CSA C22.2 No. 601.1



TECHNICAL SPECIFICATIONS

Adapta® ADP400

TABLE DIMENSIONS

NOSE AND FOOT CUSHIONS
INCLINE UP TO 90°

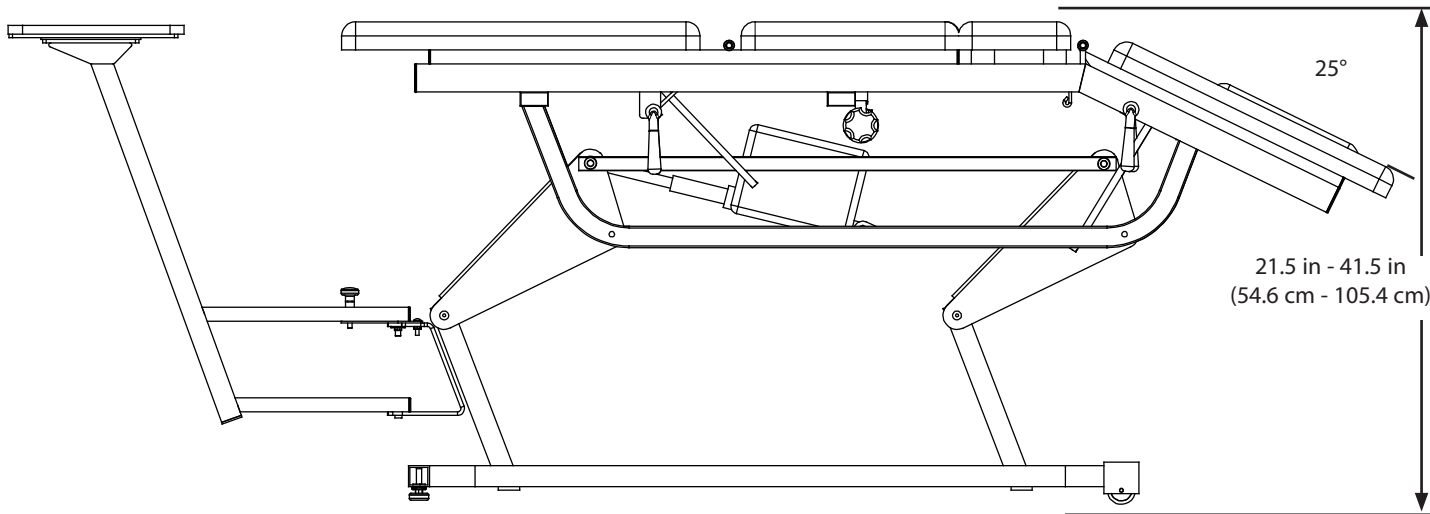

TECHNICAL SPECIFICATIONS

Adapta® ADP400

CUSHION DIMENSIONS

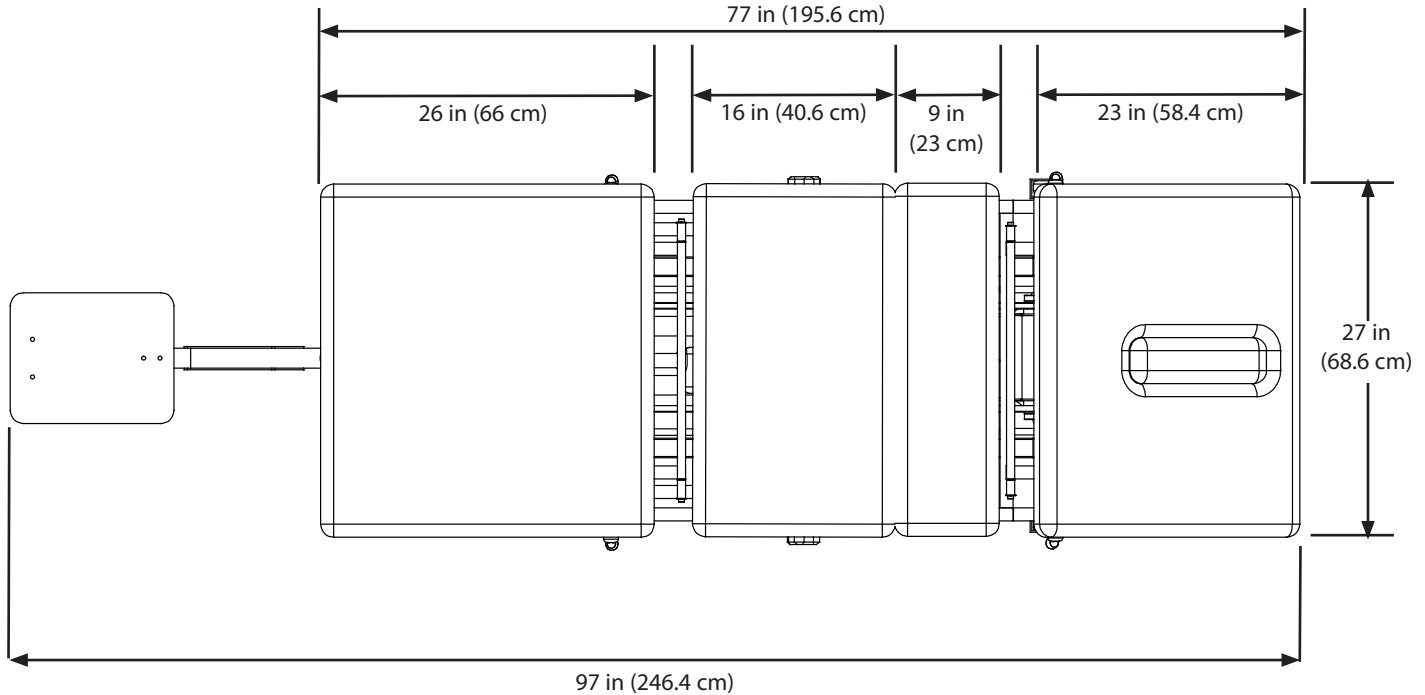

ELECTROMAGNETIC COMPATIBILITY TABLES

The following tables apply on to the 230 Vac System.

Guidance and manufacturer's declaration – electromagnetic emissions		
The Adapta ADP400 traction table is intended for use in the electromagnetic environment specified below. The customer or the user of the Adapta ADP400 traction table should assure that it is used in such an environment.		
Emission tests	Compliance	Electromagnetic environment - guidance
RF emissions CISPR 11	Group 1	The Adapta ADP400 traction table uses RF energy only for its internal function. Therefore, its RF emissions are very low and are not likely to cause any interference in nearby electronic equipment.
RF emissions CISPR 11	Class B	The Adapta ADP400 traction table is suitable for use in all establishments, including domestic establishments and those directly connected to the public low-voltage power supply network that supplies buildings used for domestic purposes.
Harmonic emissions IEC 61000-3-2	Class A	
Voltage fluctuations IEC 61000-3-3	Complies	

TECHNICAL SPECIFICATIONS

ELECTROMAGNETIC COMPATIBILITY TABLES

Guidance and manufacturer's declaration – electromagnetic immunity			
The Adapta ADP400 traction table is intended for use in the electromagnetic environment specified below. The customer or the user of the Adapta ADP400 traction table should assure that it is used in such an environment.			
Immunity test	IEC 60601 test level	Compliance level	Electromagnetic environment - guidance
Electrostatic discharge (ESD) IEC 61000-4-2	±6kV contact ±8kV air	±6kV contact ±8kV air	Floors should be wood, concrete or ceramic tile. If floors are covered with synthetic material, the relative humidity should be at least 30%.
Electrical fast transient/burst IEC 61000-4-4	±2kV for power supply lines ±1kV for input/output lines	±2kV for power supply lines ±1kV for input/output lines	Mains power quality should be that of a typical commercial or hospital environment.
Surge ⁽¹⁾ IEC 61000-4-5	±1kV differential mode ±2kV common mode	±1kV differential mode ±2kV common mode	Mains power quality should be that of a typical commercial or hospital environment.
Voltage dips, short interruptions and voltage variations on power supply input lines IEC 61000-4-11	<5% U _T (>95% dip in U _T) for 0.5 cycle 40% U _T (60% dip in U _T) for 5 cycles 70% U _T (30% dip in U _T) for 25 cycles <5% U _T (>95% dip in U _T) for 5 sec	<5% U _T (>95% dip in U _T) for 0.5 cycle 40% U _T (60% dip in U _T) for 5 cycles 70% U _T (30% dip in U _T) for 25 cycles <5% U _T (>95% dip in U _T) for 5 sec	Mains power quality should be that of a typical commercial or hospital environment. If the user of the Adapta ADP400 traction table requires continued operation during power mains interruptions, it is recommended that the Adapta ADP400 traction table be powered from an uninterrupted power supply or a battery.
Power frequency (50/60Hz) magnetic field IEC 61000-4-8	3 A/m	3 A/m	Power frequency magnetic fields should be at levels characteristic of a typical location in a typical commercial or hospital environment.
NOTE U _T is the a.c. mains voltage prior to application of the test level. NOTE ⁽¹⁾ – These results apply to the 230 Vac Power Supply.			

Guidance and manufacturer's declaration – electromagnetic immunity			
The Adapta ADP400 traction table is intended for use in the electromagnetic environment specified below. The customer or the user of the Adapta ADP400 traction table should assure that it is used in such an environment.			
Immunity test	IEC 60601 test level	Compliance level	Electromagnetic environment - guidance
Conducted RF IEC 61000-4-6	3 Vrms 150 kHz to 80 MHz	3 V	Portable and mobile RF communications equipment should be used no closer to any part of the Adapta ADP400 traction table, including cables, than the recommended separation distance calculated from the equation applicable to the frequency of the transmitter. Recommended separation distance $d = \frac{[3.5] \sqrt{P}}{f}$
Radiated RF IEC 61000-4-3	3 V/m 80 MHz to 2.5 GHz	3 V/m	$d = \frac{[3.5] \sqrt{P}}{E_{ref}}$ $d = \frac{[2] \sqrt{P}}{E_{ref}}$ where <i>P</i> is the maximum output power rating of the transmitter in watts (W) according to the transmitter manufacturer and <i>d</i> is the recommended separation distance in meters (m). Field strengths from fixed RF transmitters, as determined by an electromagnetic site survey ^a , should be less than the compliance level in each frequency range ^b . Interference may occur in the vicinity of equipment marked with the following symbol: 
NOTE 1 At 80 MHz and 800 MHz, the higher frequency range applies.			
NOTE 2 These guidelines may not apply in all situations. Electromagnetic propagation is affected by absorption and reflection from structures, objects and people.			
^a Field strengths from fixed transmitters, such as base stations for radio (cellular/cordless) telephones and land mobile radios, amateur radio, AM and FM radio broadcast and TV broadcast cannot be predicted theoretically with accuracy. To assess the electromagnetic environment due to fixed RF transmitters, an electromagnetic site survey should be considered. If the measured field strength in the location in which the Adapta ADP400 traction table is used exceeds the applicable RF compliance level above, the Adapta ADP400 traction table should be observed to verify normal operation. If abnormal performance is observed, additional measures may be necessary, such as reorienting or relocating the Adapta ADP400 traction table.			
^b Over the frequency range 150 kHz to 80 MHz, field strengths should be less than 3 V/m.			

ELECTROMAGNETIC COMPATIBILITY TABLES

Recommended separation distances between portable and mobile RF communications equipment and the Adapta ADP400 traction table			
The Adapta ADP400 traction table is intended for use in an electromagnetic environment in which radiated RF disturbances are controlled. The customer or the user of the Adapta ADP400 traction table can help prevent electromagnetic interference by maintaining a minimum distance between portable and mobile RF communications equipment (transmitters) and the Adapta ADP400 traction table as recommended below.			
Rated maximum output power of transmitter W	Separation distance according to frequency of transmitter m		
	150 kHz to 80 MHz $d = \frac{[3.5]\sqrt{P}}{f}$	80 MHz to 800 MHz $d = \frac{[3.5]\sqrt{P}}{f}$	800 MHz to 2.5 GHz $d = \frac{[7]\sqrt{P}}{f}$
0.01	0.12	0.12	0.23
0.1	0.38	0.38	0.73
1	1.2	1.2	2.3
10	3.8	3.8	7.3
100	12	12	23
For transmitters rated at a maximum output power not listed above, the recommended separation distance d in meters (m) can be estimated using the equation applicable to the frequency of the transmitter, where P is the maximum output power rating of the transmitter in watts (W) according to the transmitter manufacturer.			
NOTE 1 At 80 MHz and 800 MHz, the higher frequency range applies.			
NOTE 2 These guidelines may not apply in all situations. Electromagnetic propagation is affected by absorption and reflection from structures, objects and people.			

CONTENTS OF CRATE

After removing top and side panels of shipping crate, you may notice metal bands and plastic straps. These are used to secure various sections of the table and must be removed before the table can be lifted out. The table must be lifted directly upward in order to clear all shipping restraints.

Visually inspect for damage. Report any damage to the carrier immediately.

A MINIMUM OF TWO PEOPLE WILL BE REQUIRED TO LIFT AND MOVE THE TABLE. TABLE SHOULD BE LIFTED BY THE BASE FRAME.



- Do not lift the table by the Head Section.

Contents of Crate:

Model ADP400:

- Adapta ADP400 Table
- Traction Unit Stand
- Pivot Plate
- Mains Power Cord - 130 in (330 cm) in cable length, unshielded, 18 AWG
- Hand Control - 32 in (81 cm) in cable length, unshielded, 26 AWG
- Foot Pedal (**Optional**) - 32 in (81 cm) in cable length, unshielded, 26 AWG
- User Manual (CD-ROM)

Glide Leveler Adjustments:

Use a carpenter's level (fluid bubble type) to make adjustments to each Glide Leveler of the table and tighten each glide with a regular crescent wrench.

ATTACHING TRACTION UNIT STAND TO TABLE



Attach the Pivot Plate to the table and fasten with the two supplied 1/4-20 screws.

NOTE: Make sure that the holes of the Pivot Plate and the table are aligned before securing the Pivot Plate to the table.

Attach the two supplied 1/4-20 ESNA nuts to each screw and tighten with a 7/16" wrench.



Attach the Traction Unit Stand to the aligning holes of the Pivot Plate and the table.



Place the two supplied 13 mm flat washers underneath the Pivot Plate.



Attach the two supplied 9/16" ESNA nut and tighten with a 9/16" wrench.



Position the adjustment knob of the Traction Unit Stand to the desired degree of the Pivot Plate.

MOUNTING TRACTION UNIT TO STAND

CAUTION

- The traction stand is designed for Chattanooga traction units only. Securement of other traction units need to follow traction manufacturing recommendations. DJO, LLC is not responsible for any consequence resulting from using products manufactured by other companies.

WARNING

- To prevent accidental disengagement, the traction unit must be securely attached to the mounting surface of the traction stand. It is the responsibility of the user to verify the adequacy of the installation before use in patient therapy.

NOTE: The traction unit should be mounted facing the direction of pull so the Traction Cord does not contact the side of the slot from which it extends.



1. To secure the traction unit to the traction stand, loosen the clamp from the traction unit. Fit the traction unit to the stand and tighten the clamp up onto the stand.



2. Attach the mounting screw onto the traction stand at the front of the unit. The mounting screw is provided with traction units only.

ADJUSTING TABLE SECTIONS



WARNING

- When making adjustments to the table sections, make certain the patient weight is removed before adjusting.
- Never place your hands and feet near the working mechanism of the table when making any and all adjustments to height or table sections.



Lowering Head Section

Lift the Head Section lever and lower the Head Section to the desired elevation.

Support the Head Section when lowering.



Elevating Head Section

Raise the Head Section by hand to the desired elevation.



Locking Mid Section

Turn the Lock Release Knob toward the Lower Section of the table to lock the Mid Section in place.

Unlocking Mid Section

Turn the Lock Release Knob toward the Head Section of the table to unlock the Mid Section.

ADJUSTING TABLE SECTIONS

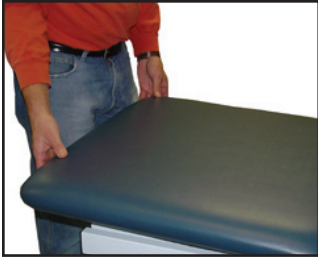

Elevating Lower Section

Raise the Lower Section to the desired elevation.



Lowering Lower Section

Turn the Lower Section lever and move the Lower Section down to the desired elevation.

TABLE HEIGHT ADJUSTMENT



Raising and Lowering Table

Push the Up Arrow button to raise the table and the Down Arrow button to lower the table to the desired height.



Raising and Lowering Table with Optional Foot Pedal

Step on the corresponding side of the foot pedal to raise or lower the table to the desired height.

RELOCATING THE TABLE (WITH OPTIONAL RETRACTABLE CASTER)



WARNING

- Never transport a patient on the ADP400 table. This table is not designed to support a patient during transport.



Moving the Table

Push the Caster Lock lever completely down with the foot. This will bring the swivel caster down to allow the table to be moved to another location.



Parking the Table

After moving the table to the desired location, raise the Caster Lock lever with toe of the shoe. This will raise the swivel caster and cease table movement.

CLEANING

After each use, clean the unit using a soft cloth dampened with water and a mild antibacterial detergent. Do not use abrasive cleansers.

SERVICE

Should the Adapta ADP400 traction table require service, contact the selling dealer or DJO, LLC Service Department.

All returned units to the factory for service must include the following:

WARRANTY REPAIR/OUT OF WARRANTY REPAIR

1. Written statement containing the following information:
 - RA Number - Obtain from Factory
 - Unit Model Number
 - Unit Serial Number
 - Contact person with Phone and Fax Numbers
 - Billing Address (for Out of Warranty Repair)
 - Shipping Address (Where to Ship Unit after Repair)
 - Detailed Description of Problem or Symptoms
2. Copy of original invoice issued at purchase of the unit.
3. Ship unit to factory in the original container with all accessories and information as required in item one above to:

DJO, LLC
Chattanooga Repair Center
47492 SD Hwy 22
PO Box 709
Clear Lake, SD 57226 USA

Service to these units should be performed only by Service Technicians certified by DJO, LLC.

WARRANTY

Adapta® ADP400

DJO, LLC ("Company") warrants that the Adapta ADP400 traction table ("Product") is free of defects in material and workmanship. This warranty shall remain in effect for one year (12 months) from the date of original consumer purchase. If this Product fails to function during the one year warranty period due to a defect in material or workmanship, Company or the selling dealer will repair or replace this Product without charge within a period of thirty days from the date on which the Product is returned to the Company or the dealer.

All repairs to the Product must be performed by a service center authorized by the Company. Any modifications or repairs performed by unauthorized centers or groups will void this warranty.

This Warranty Does Not Cover:

- Replacement parts or labor furnished by anyone other than the Company, the selling dealer, or a service technician certified by the Company.
- Defects or damage caused by labor furnished by someone other than Company, the selling dealer, or a certified Company service technician.
- Any malfunction or failure in the Product caused by product misuse, including, but not limited to, the failure to provide reasonable and required maintenance or any use that is inconsistent with the Product User's Manual.

COMPANY SHALL NOT BE LIABLE IN ANY EVENT FOR INCIDENTAL OR CONSEQUENTIAL DAMAGES.

Some locations do not allow the exclusion or limitation of incidental or consequential damages, so the above limitation or exclusion may not apply to you. To obtain service from Company or the selling dealer under this warranty:

1. A written claim must be made within the warranty period to the Company or the selling dealer. Written claims made to the Company should be sent to:

DJO, LLC
1430 Decision St
Vista, CA 92081 USA
Phone: 1-800-592-7329 USA
Phone: 1-423-870-2281 or 1-317-406-2250
Fax: 1-317-406-2014

and

2. The Product must be returned to the Company or the selling dealer by the owner.

This warranty gives you specific, legal rights and you may also have other rights which vary from location to location.

The Company does not authorize any person or representative to create for it any other obligation or liability in connection with the sale of the Product. Any representation or agreement not contained in the warranty shall be void and of no effect.

THE FOREGOING WARRANTY IS IN LIEU OF ALL OTHER WARRANTIES, EXPRESSED OR IMPLIED, INCLUDING ANY WARRANTY OR MERCHANTABILITY OR FITNESS FOR A PARTICULAR PURPOSE.

Moving Rehabilitation Forward™



DJO, LLC
1430 Decision St
Vista, CA 92081 USA
Phone: 1-800-592-7329 USA
Phone: 1-423-870-2281 or
1-317-406-2250
Fax: 1-317-406-2014
chattgroup.com

© 2010 DJO, LLC

80804_D